

Operating Instructions

ATEX - Direct Driven Centrifugal Fans

(Translation of the original)



II 3G c IIB T3 / II 2G c IIB T3

BA-CFD_REM-TEM-ATEX 7.8 - 10/2014

		<p>TEM</p>
		<p>REM</p>

Contents

1. Revision Index.....	EN-2
2. About This Operating Manual	EN-3
3. Designated Use.....	EN-5
4. Safety	EN-7
5. Product Description.....	EN-10
6. Transport and Storage	EN-11
7. Installation	EN-12
8. Electrical Connection.....	EN-13
9. Commissioning / Operation.....	EN-15
10. Maintenance.....	EN-16
11. Faults.....	EN-18
12. Service, Spare Parts and Accessories.....	EN-19
13. Annex	EN-19
EC Declaration of Conformity to EC Council Directive 94/9 EC (ATEX 95).....	EN-20
EC-Declaration of Incorporation	EN-21

German

DE-2...DE-22

Further languages on request!

1. Revision Index

Table 1-1:
Revision Index

Revision	Date
BA-CFD-TEM-REM-ATEX 7.1 – 07/2010	07/2010
BA-CFD-TEM-REM-ATEX 7.2 – 08/2010	08/2010
BA-CFD-TEM-REM-ATEX 7.3 – 08/2011	08/2011
BA-CFD-TEM-REM-ATEX 7.4 – 11/2011	11/2012
BA-CFD-TEM-REM-ATEX 7.5 – 03/2012	03/2012
BA-CFD-REM-TEM-ATEX 7.6 – 09/2013	09/2013
BA-CFD-REM-TEM-ATEX 7.7 – 01/2014	01/2014
BA-CFD-REM-TEM-ATEX 7.8 – 10/2014	10/2014

2. About This Operating Manual



These operating instructions are an integral part of the fan. Nicotra Gebhardt shall not accept any liability or provide any warranty cover for primary damage or secondary damage arising as a consequence of disregarding these operating instructions.

- ▶ Read the operating manual carefully before use.
- ▶ Retain the operating manual for the entire service life of the fan.
- ▶ Keep the operating manual accessible to personnel at all times.
- ▶ Pass the operating manual on to any subsequent owner or user of fan.
- ▶ Insert any supplementary instructions received from the manufacturer into the operating manual.

2.1. Validity

This operating manual only applies to the centrifugal fans stated on the front page.

2.2. Target Group

This operating manual is intended for operators and qualified professionals trained in installation, commissioning, operation, maintenance and decommissioning.

2.3. Other Applicable Documents

In addition to reading these instructions, due notice should also be taken of the type plate, warning signs, indicating label on the fan and the following documents and specifications:

- | | |
|----------------------|------------------------|
| - IEC 60364-1 | - DIN EN 13463-1; -5 |
| - DIN EN 60204-1 | - DIN EN 1127-1 |
| - DIN EN ISO 13857 | - DIN EN 60079-0 |
| - DIN EN ISO 12100 | - DIN EN 14986 |
| - DIN EN ISO 13732-1 | - Technical catalogue |
| | - EC-Directive 94/9/EC |

2.4. Symbols und Markings

2.4.1. Use of Warning Signs

Nature, source and consequences of hazard!



1. Steps required to avert danger



Signal word

2.4.2. Levels of Danger in Warning Signs

Table 2-1: Levels of danger in warning signs

Symbol / Danger Level	Likelihood of Occurrence	Consequences of Neglect
 DANGER!	Imminent danger	Death, serious physical injury
 WARNING!	Potential danger	Death, serious physical injury
 CAUTION!	Potential danger	Minor physical injury
CAUTION!	Potential danger	Damage to property

2.4.3. Notes

- Note** Note giving pointers for easier or safe work.
- ▶ Steps required for easier or safe work.

2.4.4. Other Symbols and Markings

Table 2-2: Other symbols and markings

Symbol	Meaning
☑	Requirement for an operation
▶	Operation with one step
1. 2. 3.	Operation with several steps
•	Bullet point (primary list)
-	Bullet point (secondary list)
Accentuation (bold)	For emphasis

3. Designated Use

3.1. Operating Data / Maximum Ratings



Risk of injury!

- ▶ Adhere to the technical specifications and permissible limits.

For technical specifications please refer should be made to the type plate, technical data sheet and technical catalogue.

Note ATEX Category II 3G IIB T3 / ATEX Category II 2G IIB T3 /

Fans of this category are designed for areas where an explosive atmosphere - as a mix of air, gases, vapors or mist - is likely to occur seldom (3G) or occasionally (2G).

The unit related measures for explosion protection of this category have to offer the necessary amount of safety, even in the case of frequent unit troubles or failure modes, to be usually anticipated (predictable troubles).

For the operation of the fans in explosion hazardous areas the relevant prescriptions, local regulations and directives (ATEX 94/9/CE) for manufacturers and user have to be respected.

Permissible conveyed medium temperatures (ATEX)

Table 3-1:
Maximum ratings

Range	Perm. temperature of conveyed medium	Max. ambient temp. on drive motor
TEM 01 / 08	-20°C to +60°C	+ 40°C
REM 11/13; 18/19	-20°C to +60°C	

Examples of incorrect use include the following:

- Extraction of media with impermissibly high or low temperatures
- Extraction of corrosive media
- Extraction of very dusty media

The results are:

- Bearing damage
- Corrosion damage
- Loss of balance
- Vibration
- Deformation
- Abrasion damage

CAUTION

Avoid dynamic load of the impeller.

No frequent alteration of load!

Unauthorised operation

- No operation above the indicated rpm (see type plate, data sheet).
- No operation at rpm ranges with increased vibration (resonance).

CAUTION

- No operation at rpm ranges out of permitted fan curve area (stability of flow pattern).
- No operation if fan becomes polluted.
- No operation with vertical motor shaft.



Danger points:
 There can be injury to personnel and material damage through impeller breakage, shaft breakage, fatigue failure, fire (explosions) from spark creation.

3.2. Explosion Protection Markings

The marking on the type label of the explosion proof fans includes the group, category, ignition class and temperature class as well as a CE-EX-sign thus confirming the conformity to the European directive 94/9/EG.

The manufacturer's declaration and the declaration of conformity 94/9 CE (ATEX 95) are attached to this maintenance instructions.

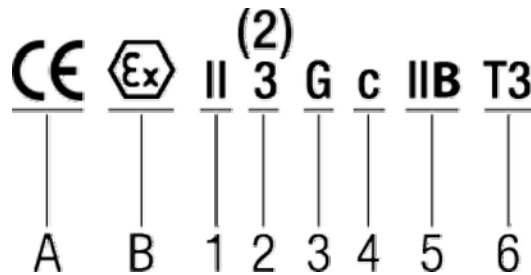

Fig 3-1:
 Explosion protection markings (example)

A	CE - Mark	
B	Hazardous duty marking	
1	Machine group II	Non-electric machines for use outside of the mining industry and underground mining
2	Machine category 3	(internal and external) for use in Zone 2; An explosive atmosphere only rarely occurs in the area and if so just for short periods
	Machine category 2	(internal and external) for use in Zones 1+2; An explosive atmosphere is only present in the area occasionally
3	Conveyed medium G	Gaseous conveying medium
4	Ignition protection c	Explosion protection through design safety
5	Explosion group IIB	Type of gaseous atmosphere
6	Temperature class T3	max. temperature on machine surface +200°C

4. Safety

4.1. Product safety

The fans offer a high degree of operational safety and high quality standards guaranteed by a certified Quality Management System (EN ISO 9001). Before leaving the factory all the fans are inspected and sealed with a mark of conformity.

Nevertheless, when operating fans there can be a risk of death or injury for the user or third parties, and a risk of damage to the fan or other material assets.

- Only use the fans in perfect working order and for its designated use as intended, having due regard for safety, an awareness of hazards and in due compliance with the operating instructions.
- Arrange immediate repair of any faults which could compromise safety.



Potentially explosive gas mixtures in conjunction with hot and moving parts may cause serious or fatal injury.

Risk of explosion due to increased ambient temperature!

- ▶ Observe ambient temperature.
- ▶ Ensure adequate supply of cooling air.

4.2. Safety Instructions

The fan may only be commissioned, operated and serviced in compliance with the following instructions:

- Operating instructions
- Warning and information signs on the fan
- Any other operating and installation instructions pertaining to the machine
- Terms and requirements relevant to the machine
- Applicable national and regional regulations, especially regarding explosion protection, health & safety and accident prevention.

4.3. Safety Devices

1. Use appropriate safeguards to prevent contact with rotating parts (shafts, impeller, etc.).
2. Protection devices are so selected so that sucking or falling-in of objects will be prevented.
3. After installation (and before electrical connection) immediately refit any guards which have been removed during installation.



The fans are delivered without inlet- and discharge guards. If there is a danger of contact with the impeller owing to the way the fan is installed, then it is necessary to fit guards conforming to DIN EN ISO 13857 (available as an accessory).

Only then can the fan be set in operation!



DANGER!

ATEX fans of categories 2G or 3G are made for integration into installations. Care must be taken to avoid any ingress of object into the fan. (min. IP20 to EN 60529).

The user has to find corresponding protection in order to ensure a safe operation!



CAUTION!

The suitability of protection devices and their fixtures to the fan have to be evaluated within the overall security concept of the installation.

4.4. Professional Staff

1. Ensure that the Installation of the fan and any work on it is carried out by skilled professionals only with due regard to these operating instructions and any applicable regulations.
2. Electrical connection to be carried out by qualified electricians only.

4.5. Protective Gear



CAUTION!

Ensure that members of staff are wearing protective gear appropriate to their deployment and environment.

The protective clothing is specified below!

4.6. Specific Hazards

4.6.1. Noise Emission



The sound emission expected during normal use of the fan is documented in the technical lists and should be duly taken into account.

- ▶ **Wear ear defenders when working near to or on the running fan!**

4.6.2. Heavy Loads

The heavy weight of the fan and its components entail the following risks in transit and during installation:



- Risk of being trapped, crushed or cut by moving or toppling machinery
- Danger of falling components
- ▶ **Do not stand or work under suspended loads.**
- ▶ **Wear a hard hat, safety shoes and gloves.**

4.6.3. Rotating Shafts and Impellers

Objects falling onto rotating shafts and impellers can fly off at an angle and cause serious injury.



Articles of clothing and hair can get caught in rotating shafts and impellers.

- ▶ **Do not remove guards during operation.**
- ▶ **Do not wear loose-fitting clothing**
- ▶ **Wear goggles**

4.6.4. Hot Surfaces



There is a risk of sustaining burns or scalds on hot surfaces during operation.

- ▶ Do not touch the motor during operation.
- ▶ When the fan has stopped wait until the motor has cooled down.
- ▶ Wear protective gloves

4.7. Structural Modifications, Spare Parts

Note Unauthorised modifications are prohibited.

The manufacturer do not accept liability for any damage arising as a result of unauthorised modifications.

Use only genuine spare parts of Nicotra Gebhardt.



In areas subject to explosion hazards the fan may only be modified or converted by Nicotra Gebhardt itself, by a service location approved by the company, or by personnel authorised and trained by the company.

4.8. Installation and Maintenance

The following steps should be taken before working on the fan:

1. Ensure that the atmosphere is not potentially explosive.
2. Switch off the machine and take measures to prevent it from being switched back on accidentally.
3. Display the following message on a sign:

Do not switch on! Work currently in progress on the machine

4.9. Signs on the Fan

Depending on the model, the type plate and the arrow indicating the direction of rotation are fitted to the housing or handle for high visibility.

4.9.1. Type plate

Fig 4-1:
Example type plate

NICOTRA Gebhardt D-74638 Waldenburg Tel.: +49 (0) 7942 101 384 Fax.: 385 email: service@gebhardt.de REM 18-0560-4X-19-2G RD/90					
GERÄTE-NR.	125-365083-275018/1	HERSTELLJAHR	2010		
VENTILATOR			MOTOR		
n max	= 1500 1/min	U N	= 230/400	V (D/S)	
Dichte	= 1.2 kg/m3	f N	= 50	Hz	
Tmax	= 60 °C	I N	= 12/7,5	A	
				1/min	
				kW	
				°C	
			Schutzart	IP 55	
			Wärmeklasse	F	
			Stromart	3~	
CE II 2G c IIB T3 (innen/aussen)					



4.9.2 Arrow Indicating Direction of Rotation

Fig 4-2:
Arrow indicating direction of rotation



4.9.3 Terminal Board Circuit Diagram

Fig 4-3: The wiring diagram is in the terminal box of the motor.

Example circuit diagram

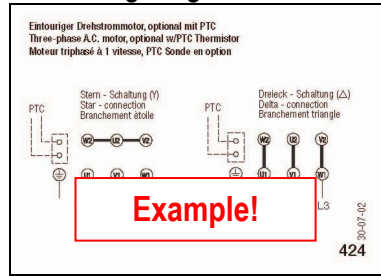

5. Product Description

5.1. Centrifugal fan direct driven TEM / REM



The centrifugal fan, single inlet direct driven by standard IEC motor, does meet the requirements of ATEX regulation 94/9/CE by its safe design and controlled production procedures corresponding to EN 14986 and DIN EN 13463-1/-5. Classification is made – according to the corresponding type plate – to group II, category 2G (REM) or 3G (TEM), explosion group IIB and temperature class T3.

TEM: Impeller with forward curved blades

REM: Impeller with backward curved airfoil blades

Materials:

- **Impeller** made of sheet steel, coated (REM), of galvanized sheet steel (TEM)
- **Inlet cone** made of copper

Note The ATEX fan must not be modified by the user. Any modification will render ATEX conformity invalid.

5.2. Centrifugal fans, direct driven TEM / REM

5.2.1 Centrifugal fans TEM / REM single inlet, direct driven

Fig. 5-1: REM 11/13-0200/-0355

REM 11/13-0400/-0630

Ranges TEM 01-0160/-0355

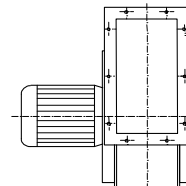
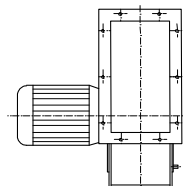

REM 18/19-0200/-0355

REM 18/19-0400/-0630

TEM 08-0160/-0355

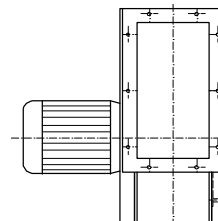
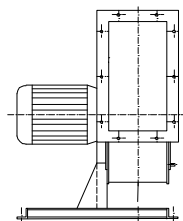

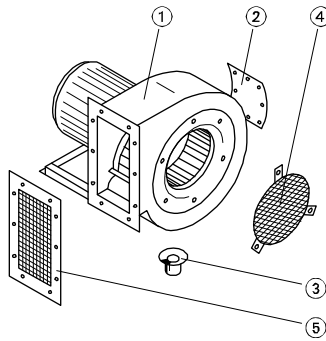

Fig. 5-2: Accessories

1 Fan

Important accessories

2 Access door (duty accessory)

3 Drain plug

4 Inlet guard

5 Discharge guard

- Safety of machinery DIN EN ISO 13857

- Degrees of protection DIN EN 60529

CAUTION

A drain plug (available as an accessory) must be inserted at in the lowest point in the casing if the fan is installed outdoors or the media is damp.

6. Transport and Storage

6.1. Packaging

Fans are packaged in fitting cardboard boxes or wooden crates. Instructions for removing transportation locks are enclosed.

6.2. Symbols on Packaging

The following symbols are printed on the cardboard boxes:

Table 6-1:
Symbols on packaging

Symbol			
Meaning	Handle with care	Keep dry	Top

6.3. Transportation of Fans



Danger of injury from falling components!

- Use tested and appropriate load handling equipment only (see type plate or data sheet).
- Transport the fan in the original packaging for as long as possible.
- Secure the load.
- Do not stand under suspended loads.

1. Select means of transport according to weight and dimensions of fan. (For weights please see the technical catalogue)
2. Fan must be attached at the base frame, base plate or supporting plate. Lift the fan by the base frame and/or by the carrier plate only.
3. When using transport belts always provide 4 points of suspension (2 belts). The belt may not exert a deforming force on the fan or its packing. If necessary, use a spacer!
4. Secure load with belts or fix it against sliding!
5. Handle centrifugal fan with care to prevent damages to avoid e.g. shock or rough placement.

CAUTION These are **NOT** fixing points at the fan:

- Motor lifting ring bolt
- Intake and discharge casing flange

6.4. Storage of Centrifugal Fan**CAUTION** Risk of corrosion!

- ▶ Store the fan in its packaging adding any other protection dictated by its storage environment.
- ▶ Store centrifugal fan in a well-ventilated room only at normal temperatures and in a non-corrosive atmosphere.
- ▶ Store centrifugal fan in conditions registering less than 70% atmospheric humidity.
- ▶ Adhere to max. permissible temperature of -20°C to $+40^{\circ}\text{C}$.

7. Installation**7.1. Safety Instructions for Installation**

- ▶ Observe the safety instructions and preventive measures in Chapter 4 and the relevant legal requirements.

CAUTION ATEX fans TEM / REM must be mounted with a horizontal motor shaft.**CAUTION** ATEX fans must not be modified in any way at site!

Its operation is exclusively permitted in its state as originally supplied and within the specified limits. (respect catalogue and type plate data).

7.2. Preparing for Installation

- The place of installation must be suitable for the fan in terms of its category, condition, ambient temperature and environmental media.
- The base must be level and have sufficient load-bearing capacity.
 1. Unpack centrifugal fan carefully.
 2. Unfasten or dismantle transport locks
 3. Packing material to be fully removed and disposed.

7.3. Carrying out the Installation

1. The fan or base frame must be fixed without stressing to the supporting structure.
2. AVM to be regularly placed around centre of gravity and definitely fixed. Check whether the AVM is evenly under load.
 - The fan is mounted with a horizontal motor shaft.
 - The fan and flexible connections are earthed correctly.
 - No forces or vibrations may be transferred from other plant parts to the fan (flexible connection).
 - The flexible connections at intake and/or discharge are installed, well aligned and freely moving.
 - The AVM are freely moving and under even load!
 - The impeller is turning idly and does not touch the intake cone!
 - The stability of the fan against collapse of the fan has been checked.

Conveying humid air outside installation:

- A condensate water drain is fitted to the lowest point of the casing

7.4. Checking the Gap Dimension on the Fan

- Ensure that the gap width on the fan between the inlet nozzle and the impeller complies with the data in the following table

(The width cannot be checked once the fan has been installed.)

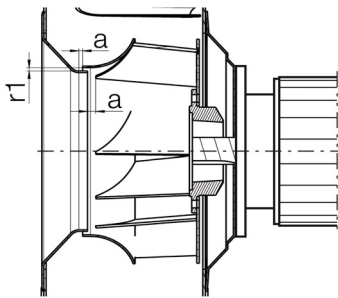

Fig. 7-1:
Gap width

Fan	Gap	
	r1	a
REM 0200-2G / 3G	2,0 mm	2,0 mm
REM 0225-2G / 3G	2,0 mm	2,0 mm
REM 0250-2G / 3G	2,0 mm	2,0 mm
REM 0280-2G / 3G	2,2 mm	2,2 mm
REM 0315-2G / 3G	2,4 mm	2,4 mm
REM 0355-2G / 3G	2,7 mm	2,7 mm
REM 0400-2G / 3G	3,0 mm	3,0 mm
REM 0450-2G / 3G	3,4 mm	3,4 mm
REM 0500-2G / 3G	3,8 mm	3,8 mm
REM 0560-2G / 3G	4,3 mm	4,3 mm
REM 0630-2G / 3G	4,8 mm	4,8 mm

Table 7-1: Gap width

1. Measure the gap and ensure that the width of the gap does not fall below the threshold in any phase of the rotation (manual rotation).
2. Carry out measurements on four 90° points on the circumference.

7.6. Install protective devices

1. Fit guards to protect exposed inlet or discharge (EN ISO 13857).
2. Design safety devices in such a way that they prevent objects from being sucked in or from falling in (see EN 60529).

8. Electrical Connection

8.1. Safety Instructions for Electrical Connection



Danger of electric shock!

- Observe the safety instructions and preventive measures in Chapter 4 as well as the relevant legal requirements.

EN 60204-1, IEC 60364-1, DIN EN 60079-0, VDE 0170-1 DIN EN 60079-14, VDE 0165-1

All the fans are delivered ready for connection. The terminal box is easily accessible. The wiring diagram is in the terminal box.

CAUTION

Inspection switches, electronic control units and frequency converters can cause material damage!

- ▶ Do not use inspection switches, electronic control units or frequency converters in areas subject to explosion hazards.
- ▶ Install inspection switches - except inspection switches approved for areas subject to explosion hazard – outside the area subject to explosion hazards.

CAUTION Excessive te-time can cause material damage!

When using overload protective devices do not exceed the te-time stated on the motor rating plate.

Note The standard motors are classified as protection category “Increased Safety EExe II”, temperature class T1 to T3, and insulation class B (-20°C to +40°C) in accordance with Directive 94/9/EC (ATEX 95) and IEC/EN 60079-0, IEC/EN 60079-7.

- ☑ Current, voltage and frequency of mains supply checked for conformity with fan type plate and motor rating plate.
- ☑ Star-delta or soft start provided for motors with a nominal output >4 kW.
- ☑ Adhere to the output limits imposed by the power supply company
- ☑ If necessary, an Isolator must be provided(outside the area subject to explosion hazards)
- ☑ All components are provided with an earthing. The fan components are electrically connected to each other.
- ☑ **The fan is protected against unexpected start!**
- ☑ **Chapter 4. „Safety“ must be respected!**

8.2. Connecting the Motor

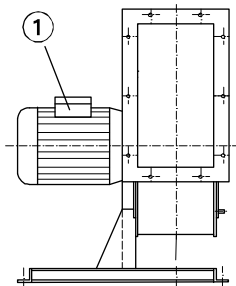

Fig. 8-1: Connection REM

1. Fit inspection switch if applicable.
2. Connect feed line to fan or service switch.
3. Connect motor as shown on connection diagram supplied.
4. Ensure that all the electrical safety devices have been fitted and connected.

1 = Connection box

8.3. Motor Protection

- Protect motors against overload in accordance with DIN EN 60204-1.
- Only motors conforming to the corresponding ATEX – category of the fan are permitted.
- Motor protection switches must be set to the nominal motor current (see type plate). A higher setting value is not admitted!
- Respect the te–time for overload protection indicated on the motor type plate.

CAUTION Fuses or circuit breakers do not provide sufficient motor protection. Damage due to insufficient motor protection invalidates the manufacturer’s guarantee.

Note In all cases the power limitations provided by the existing power supply company must be taken into account.

If plant conditions necessitate a direct start the suitability of the fan design must be confirmed with Nicotra Gebhardt. Fans with high inertia impellers can take over 6 seconds to reach top running speed. In these cases heavy duty motor protection relays or bimetal relays must be provided.

8.4. Carrying out a Test Run



Risk of injury from rotating impeller!

► Never reach into the impeller when the fan is open.

1. Take measures to prevent the centrifugal fan from being switched on accidentally
2. Clear the ducting system and fan of all foreign bodies (tools, small parts, construction waste, etc).
3. Close all the inspection openings.
4. Switch on the fan and check the direction of rotation of the impeller by comparing it with the arrow on the fan indicating the direction of rotation.
5. If the direction of rotation is wrong, reverse the polarity of the motor having due regard to the safety instructions.
6. Once operating speed has been reached measure the current consumption and compare it with the nominal motor current on the fan type plate or motor rating plate
7. If there is continuous overload switch the fan off immediately.
8. Check that the fan runs smoothly and quietly. Ensure that there are no unusual oscillations or vibrations.
9. Check the motor for any abnormal noises.

9. Commissioning / Operation

The motors are designed for continuous operation S1. If operations involve more than three starts per hour Nicotra Gebhardt shall be required to confirm the suitability of the motor.



Potentially explosive gas mixtures in conjunction with hot and moving parts may cause serious or fatal injury.

Risk of explosion due to increased ambient temperature!

- Observe ambient temperature
- Ensure adequate supply of cooling air

9.1. Conditions for Commissioning in Ex-Area

The following requirements must be met before operating the fan in areas subject to explosion hazards:

- Type plate specifications meet the standards required in the local operating conditions in respect of explosion hazards (machine group, explosion hazard category, explosion hazard zone, temperature class).
- All the components connected to the fan carrying a risk of ignition or explosion to have the required approval certificates.
- The ambient temperature during subsequent use to be within in the

allowed limits!

- ☑ All the requisite safety devices to be installed.
- ☑ Prevent impeller from contact and being hit by falling or sucked-in objects.
- ☑ The fan is not operated in a dusty environment.
- ☑ Ensure that no unacceptable levels of dust gather on the fan.

9.2. Commissioning the fan



Risk of injury from rotating parts and hot surfaces!

1. Ensure that all the safety devices are fitted.
2. Ensure that the impeller has been secured acc. to DIN EN ISO 13857!

Action

1. Check the working order of all the connected control instruments.
2. **Switch on the fan.**

10. Maintenance

10.1. Safety Instructions for Maintenance

- ▶ Observe the safety instructions and preventive measures in Chapter 4 as well as the relevant legal requirements.
- ▶ Follow the directions of the motor supplier and the instructions specified by the manufacturers of the switches and control units.



Work on the fan is only permitted when the power supply is fully cut!

Pressure washers can cause damage to property!

CAUTION

Do not use pressure washers (steam jet cleaners) to clean the equipment.

CAUTION

Unsealed flexible connections leads to breakdowns and danger from escaping transported medium and must be replaced.

10.2. Observing Regular Inspection Intervals

In the interests of upkeep and safety we recommend having the operation and condition of the fans inspected at regular intervals by duly qualified service personnel or a professional maintenance firm and documenting these inspections.

The nature and extent of the maintenance work, the service intervals and any additional work required needs to be specified on a case-by-case basis depending on the use of the fans and the general conditions on site.

Our servicing and inspection recommendations based on VDMA 24186-1 can be found on our website.

10.3. Preparing for Maintenance

1. Disconnect the motor from the mains.
2. Switch off the fans using the inspection switch (if fitted).
3. Take measures to prevent the fan from being switched on accidentally.
4. Wait until the impeller has stopped.
5. Wait until all hot surfaces have cooled down.
6. Remove any residues from the fan

7. Depending on the situation installation components may be dismantled for inspection and maintenance.

Preparation for maintenance is completed

10.4. Maintenance recommendations for centrifugal fans

Table 10-1:

Maint. recommendation

- ▶ Conduct test run if applicable (see Chapter 8.4).
- ▶ Document inspection intervals observed.

POS	Description			
1.0	Fan	quarterly	cyclic	on demand
1.1	Check deposit, damages, corrosion and fixing	X		
1.2	Check impeller for damage and unbalancing, vibration check	X		
1.3	Check flexible connections for tightness	X		
1.4	Check correct function of AVM	X		
1.5	Check correct function of safety devices (guards)	X		
1.6	Check condensate water drain	X		
1.7	Clean entire unit in order to keep all elements in best working conditions	X		x
1.8	Check rotational sense of impeller (for all speeds)	X		
1.9	Check fan function and its readiness for immediate start up		X	
2.0	Motor	quarterly	cyclic	on demand
2.1	Visual control for dirt, damages, corrosion and correct fixing	X		x
2.2	Check rotational sense	X		
2.3	Check bearing noise	X		
2.4	Lubricate bearing (where bearings are re-lubricable)		X	
2.5	Check correct function of safety devices (guards)	X		
2.6	Check tight electrical connections on tight fixing	X		
2.7	Clean entire unit in order to keep all elements in best working conditions	X		x

10.4.1 Vibration monitoring

The fan has to be frequently checked for vibrations. The max. vibration velocity values admitted are those which relate to ISO 14694.

Table 10-2: Vibrations

Size	Vibrations [mm/s]
≤0315	≤ 7.1
0355	≤ 4.5

These vibration velocities are to be measured in a radial direction on the bearing or bearing casing of the motor.

Deposits of dirt and dust on the impeller can cause unbalancing and subsequent damages. In order to prevent this danger frequent inspections and cleaning measures have to be carried out depending on the degree of possible deposit.

10.4.2 Motor bearings

The motor bearings are supplied permanently lubricated by the factory; experience has shown that the grease needs to be changed only after several years only under normal operating conditions!

In the case of bearing noise please contact Nicotra Gebhardt-Service for a check and a possible change of defective bearings

10.4.3 Periods of stand still

During longer periods of standstill the fan must from time to time be put into operation for a short while. This is to avoid bearing damages due to the mechanical load and ingress of humidity. After longer periods of storage, the fan and motor bearings have to be checked prior to installation.

CAUTION

If the condition of the fan does not allow modified repair measures it must be put off commission immediately and be replaced if required.

11. Faults

If any faults occur during operation which cannot be repaired by maintenance personnel please contact the service department at Nicotra Gebhardt GmbH.



WARNING!

Risk of explosion caused by improper operating states!

- ▶ Switch the fan off immediately if permissible limits are exceeded and in the event of irregularities or faults.

12. Service, Spare Parts and Accessories

Nicotra Gebhardt GmbH
Gebhardtstrasse 19-25
74638 Waldenburg
Germany

Telephone: +49 (0) 7942 101 384
Fax: +49 (0) 7942 101 385
E-mail: info@nicotra-gebhardt.com
www.nicotra-gebhardt.com

12.1. Ordering Spare Parts

- Use only genuine spare parts supplied by Nicotra Gebhardt as featured in the list of spare parts.

The use of spare parts supplied by other manufacturers may compromise the safety of the equipment. Nicotra Gebhardt shall not accept any liability or provide any warranty cover in respect of primary or secondary damage arising as a consequence of using spare parts supplied by other manufacturers.

Spare parts can be ordered online at - www.gebhardt.de/partshop

12.2. Accessories

Nicotra Gebhardt has a wide range of accessories for the economical and efficient use of the fan. Accessories are optional and always need to be ordered separately. Spare parts should be selected on the basis of the technical specification or via our electronic selection program. Accessories are supplied with separate operating or installation instructions unless their installation or uses are self-explanatory.

13. Annex

13.1 Further Documentation by Nicotra Gebhardt

Table 13 1:
Further documentation

Type of Documentation	File Location
Maintenance and inspection recommendations	Internet, see Chapter 10.3.
EC-Declaration of Conformity	Annex
EC-Declaration of Incorporation	Annex

EC Declaration of Conformity

to EC Council Directive 94/9 EC (ATEX 95)

We herewith declare that the machinery designated below, on the basis of its design and construction in the form brought onto the market by us is in accordance with the relevant safety and health requirements of the EC Council Directive as mentioned below.

If any alterations are made to the machinery without prior consultations with us this shall render the declaration invalid.

Designation:

Centrifugal fans with scroll of categories 2G and 3G for conveying explosive atmosphere

Machine type:

TEM ..-3G

REM ..-2G / 3G

Year of Production/Type:

see machine label

Relevant EC Council Directive:

EC Council Directive 94/9/EC (ATEX 95)

EC-certificate number:

EX9 11 09 78300 005 (only type 2G)

Applied harmonized standards ¹⁾, in particular:

EN 13463-1, EN 13463-5, EN 1127-1, EN 14986

It is the responsibility of the manufacturer or contractor to ensure that conformity to these standards is observed when installing the fan in a machine or system.

Waldenburg, 14.01.2014



i.V. I. Stöbe
Head of Production



i.V. Dr. J. Anschütz
Research & Development Director

¹⁾ For the complete list of applied standards and technical specifications please see the manufacturer's documentati

EC-Declaration of Incorporation

The manufacturer: **Nicotra Gebhardt GmbH**
Gebhardtstrasse 19-25, 74638 Waldenburg, Germany

herewith declares, that the following product:

Product designation: Centrifugal fan
Type nomination: **TEM ..-3G / REM ..-2G bzw. REM ..-3G**
Serial n°: see type plate
Year of manufacture: see type plate

qualifies as a partly completed machine, according to Article 2, clause “g” and complies with the following basic requirements of the Machine Directive (**2006/42/EC**): Annex I, Article **1.1.2; 1.3.7**

The partly completed machine may be put into operation only if it has been stated that the machine into which the uncompleted machine has to be incorporated complies with the requirements of the Machine Directive (2006/42/EC).

The following harmonised standards¹⁾ have been applied:

- **DIN EN ISO 12100**: Safety of machines – General design principles
- **DIN EN ISO 13857**: Safety of machines – Safety distances to hazardous areas

The manufacturer is committed to providing the special documents for partly completed machines to any state authority on request.

Waldenburg, 13.09.2013

Representative for the documentation: Michael Hampel



i.V. I. Stöbe
Head of Production



i.V. Dr. J. Anschütz
Research & Development Director

1) The complete listing of applied standards and technical specifications see manufacturer's documentation.

NICOTRA || **Gebhardt**
fan|tastic solutions

Nicotra Gebhardt GmbH
Gebhardtstrasse 19-25
74638 Waldenburg, Germany

Telephone +49 (0)7942 1010
Fax +49 (0)7942 101170

E-mail info@nicotra-gebhardt.com
www.nicotra-gebhardt.com